

### TOP VIEW

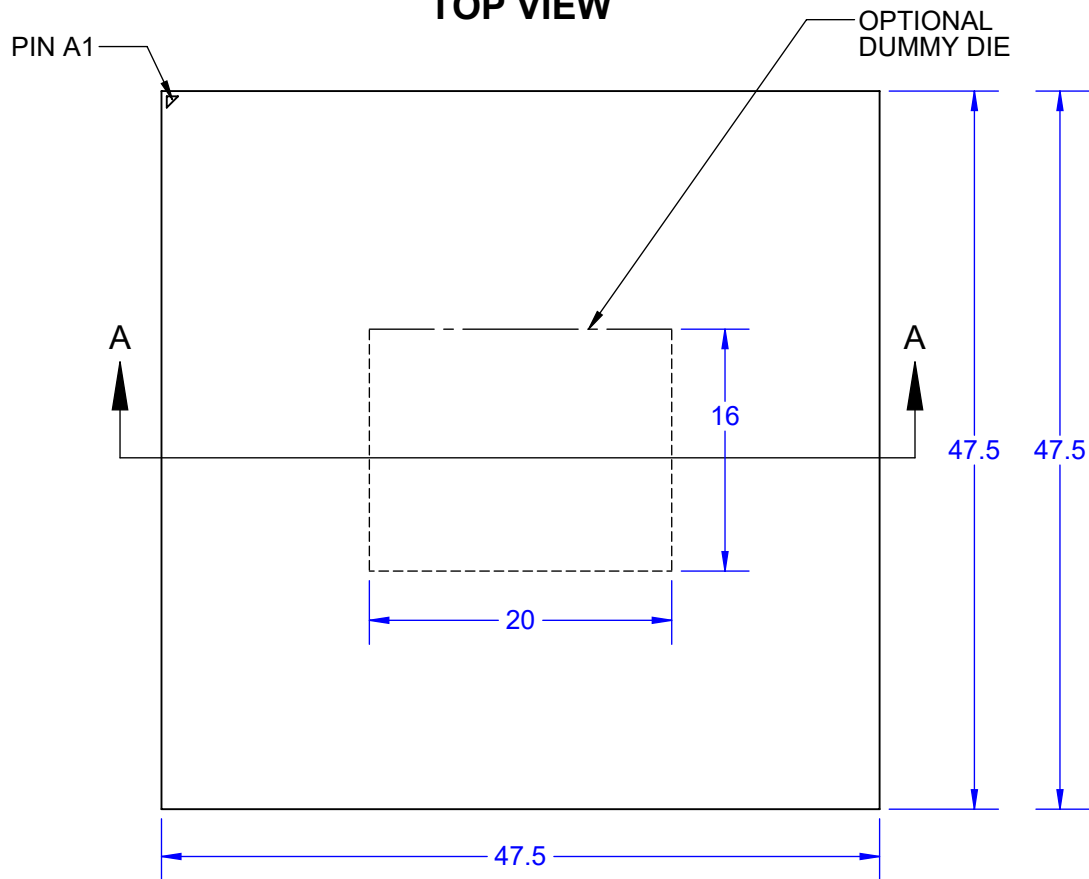

### BALL VIEW

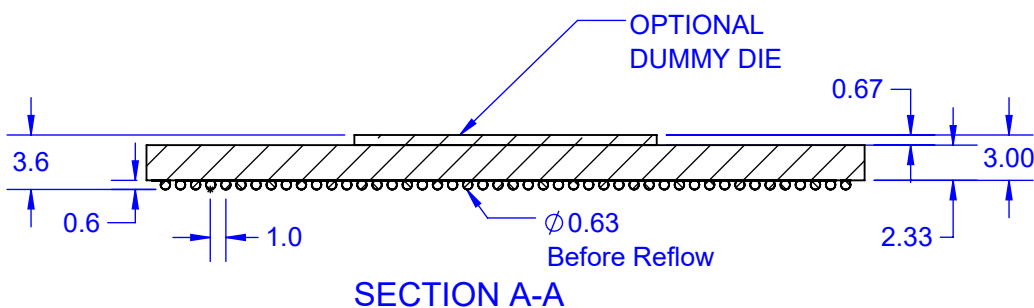
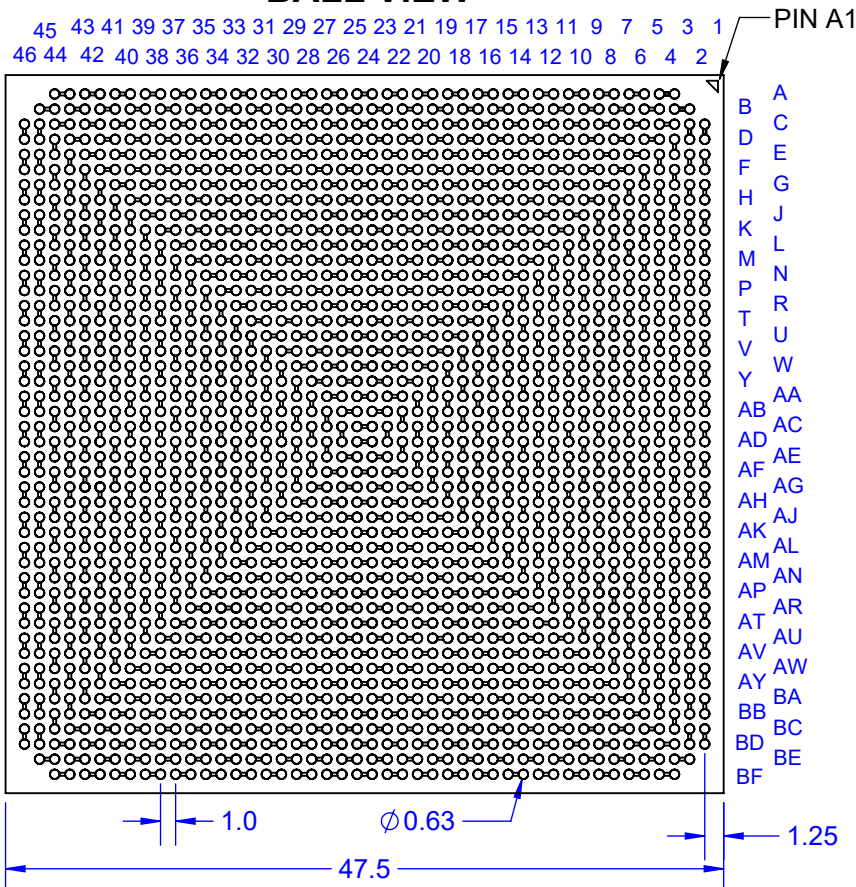

Notes: (Unless Otherwise Specified).

- 1) ALL DIMENSIONS ARE IN MM.
- 2) SOLDER BALL ALLOY: SEE PART NUMBER TABLE.
- 3) BALL DIAMETER (BEFORE REFLOW): 0.635mm (25 MIL).
- 4) SOLDER MASK DEFINED PAD OPENING: 0.508mm (20 MIL).
- 5) PAD Cu DIAMETER: 0.635mm (25 MIL).
- 6) SUBSTRATE MATERIAL: BT (ALTERNATE FR4 or Polyimide).
- 7) DUMMY DIE IS OPTIONAL.
- 8) DAISY CHAIN PATTERN (SEE PAGE 2).
- 9) MSL-3 RECOMMENDED BAKING 24 HOURS @ 125°C TO REMOVE MOISTURE PRIOR SOLDERING TO PC BOARD.

#### PART NUMBER TABLE

PART NUMBER	BALL ALLOY	BALL ALLOY	RoHS	Si DIE
LBGA2104T1.0C-DC467D	Sn96.5/Ag3.0/Cu0.5	SAC305	YES	YES
LBGA2104T1.0C-DC467	Sn96.5/Ag3.0/Cu0.5	SAC305	YES	NO
LBGA2104T1.0-DC467D	Sn63/Pb37	Sn63	NO	YES
LBGA2104T1.0-DC467	Sn63/Pb37	Sn63	NO	NO

APPROVALS	DATE				
DRAWN T.Au	1/10/2021				
ENG M. Hart	1/10/2021	TITLE LBGA2104T1.0-DC467D DAISY CHAIN DUMMY			
MFG		SCALE	SIZE	DRAWING NO.	REV
QA		2:1	A	514671	A
CUST		DO NOT SCALE DRAWING			SHEET 1 OF 9
REVISED					

# BALL VIEW

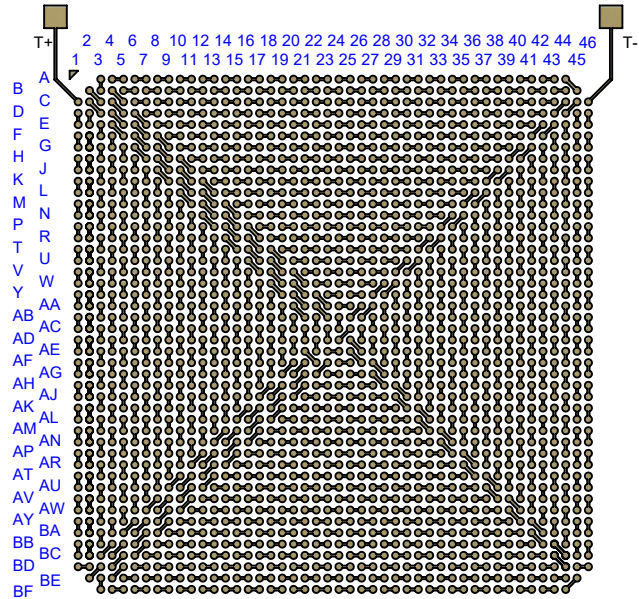
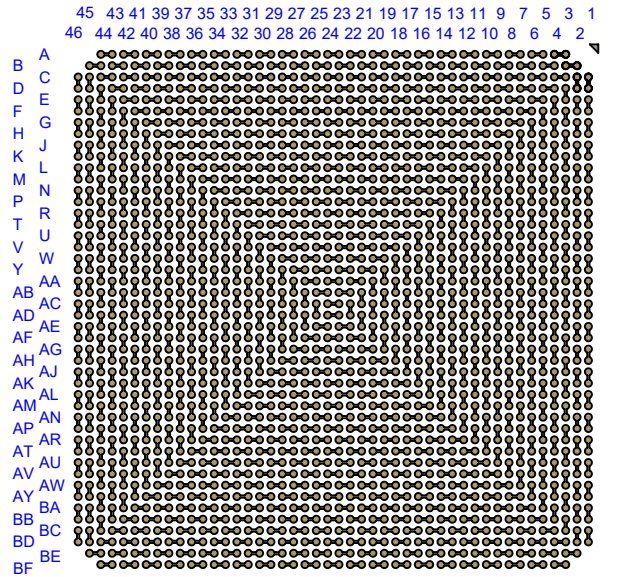

## TEST VEHICLE BOARD

# BOTTOM SIDE (TOP X-RAY VIEW)

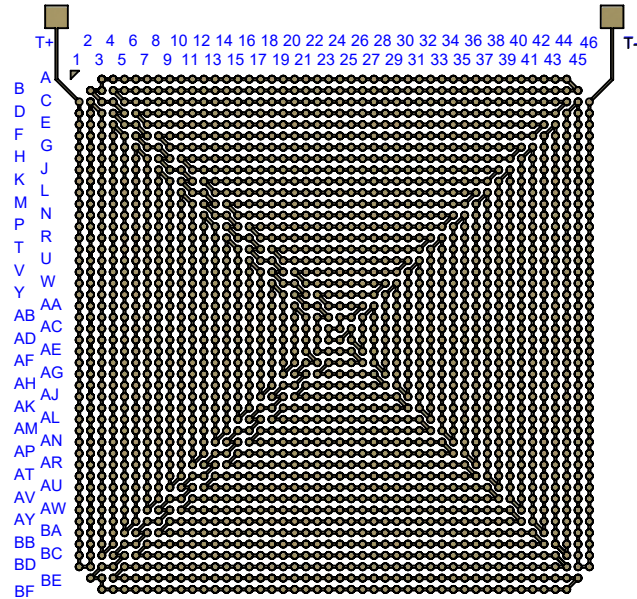
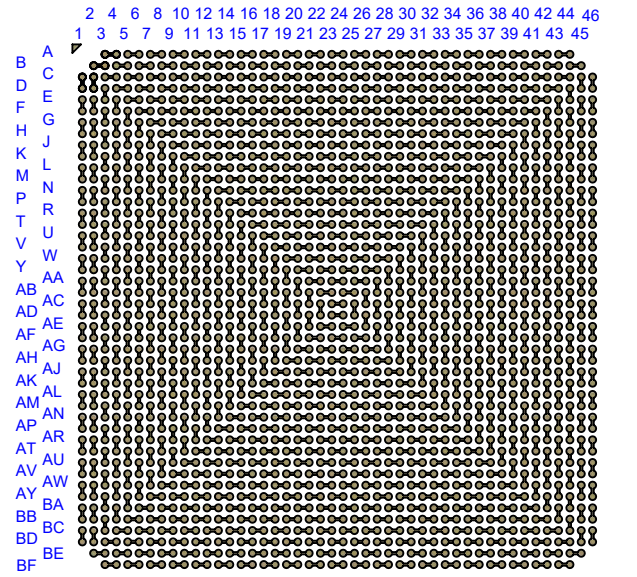

## AFTER MOUNTING

**Notes:**

- 1) PCB BOARD DIMENSIONS ARE PRESENTD ONLY AS A GUIDELINE. DESIGNERS SHOULD USE THEIR OWN EXPERIENCE WHEN DESIGNING PCB.
- 2) PCB Cu BALL PAD DIAMETER 0.635mm [25 MIL].
- 3) PCB DAISY CHAIN TRACING LINE WIDTH 0.204mm [8 MIL].
- 4) SMD (SOLDER MASK DEFINED) PAD OPENING 0.508mm [20 MIL].



TITLE			
LBGA2104T1.0-DC467D DAISY CHAIN DUMMY			
SCALE	SIZE	DRAWING NO.	REV
3:2	A	514671	A
DO NOT SCALE DRAWING			SHEET 2 OF 9

# BALL VIEW

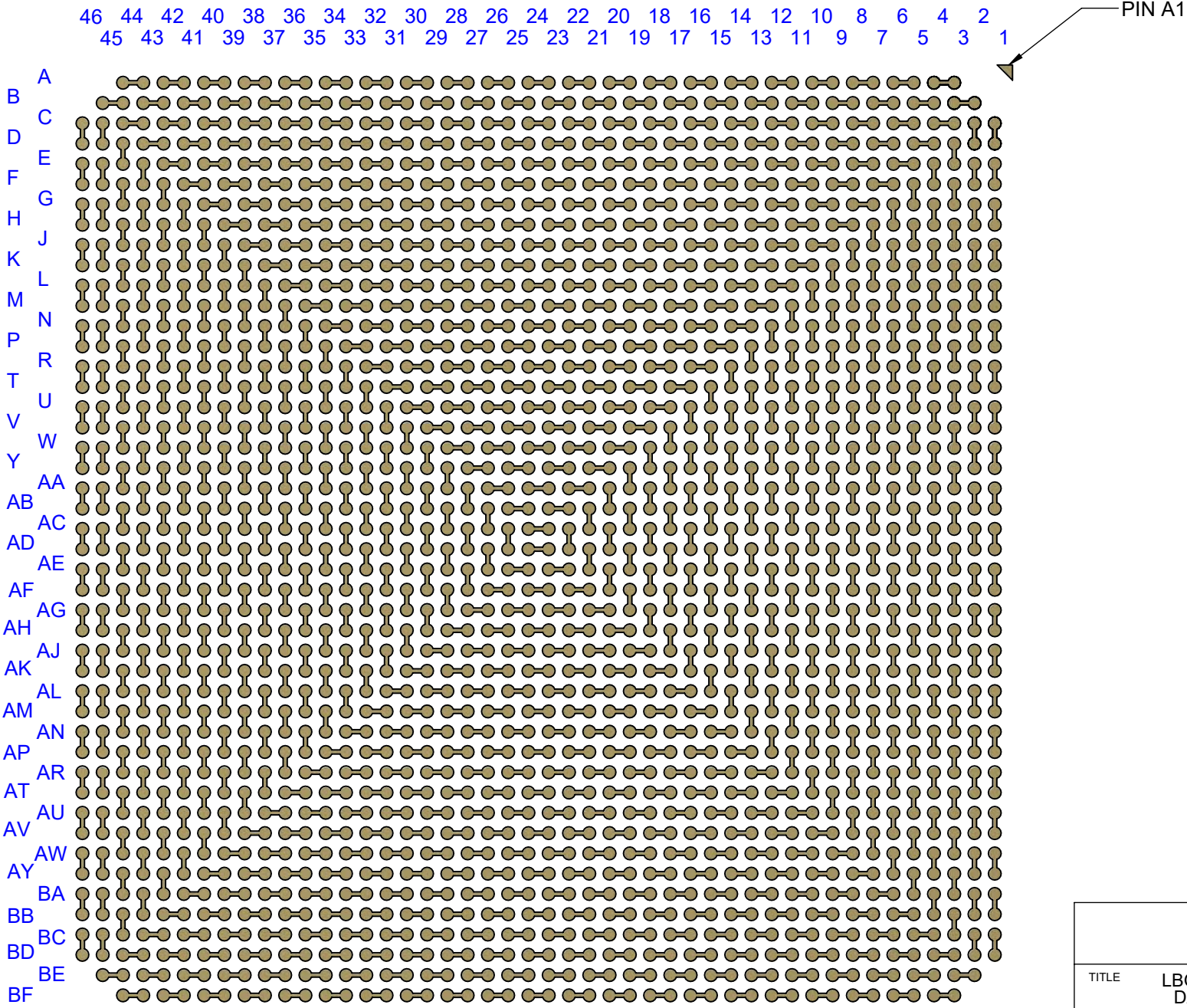

<b>TopLine®</b>			
TITLE LBG2104T1.0-DC467D DAISY CHAIN DUMMY			
SCALE 3.5:1	SIZE A	DRAWING NO. 514671	REV A
DO NOT SCALE DRAWING			SHEET 3 OF 9

# BOTTOM SIDE (TOP X-RAY VIEW)

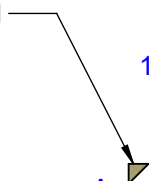
PIN A1 

1 3 5 7 9 11 13 15 17 19 21 23 25 27 29 31 33 35 37 39 41 43 45  
2 4 6 8 10 12 14 16 18 20 22 24 26 28 30 32 34 36 38 40 42 44 46

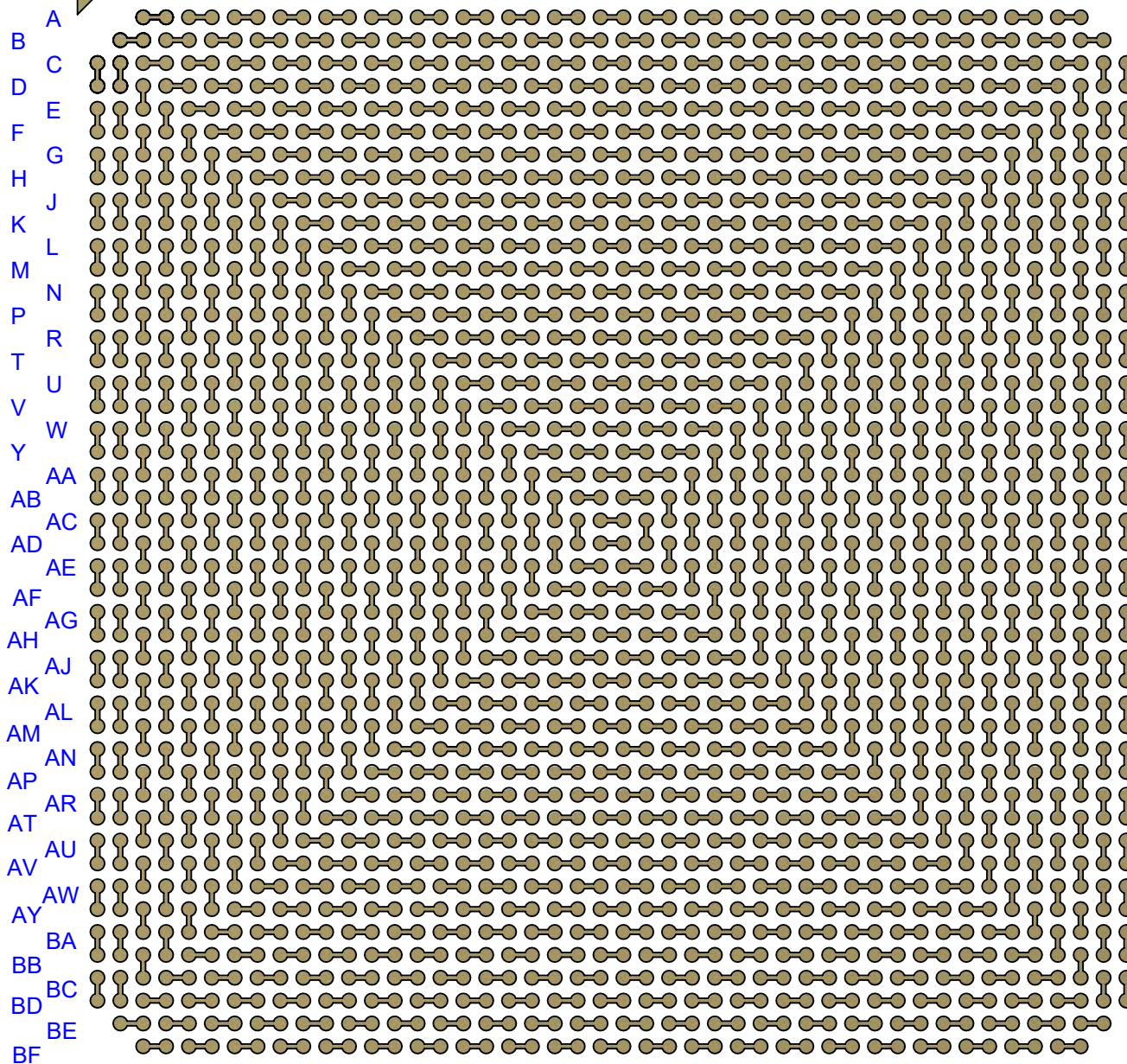

<b>TopLine®</b>			
TITLE    LBG2104T1.0-DC467D DAISY CHAIN DUMMY			
SCALE	SIZE	DRAWING NO.	REV
3.5:1	A	514671	A
DO NOT SCALE DRAWING			SHEET 4 OF 9

# TEST VEHICLE BOARD

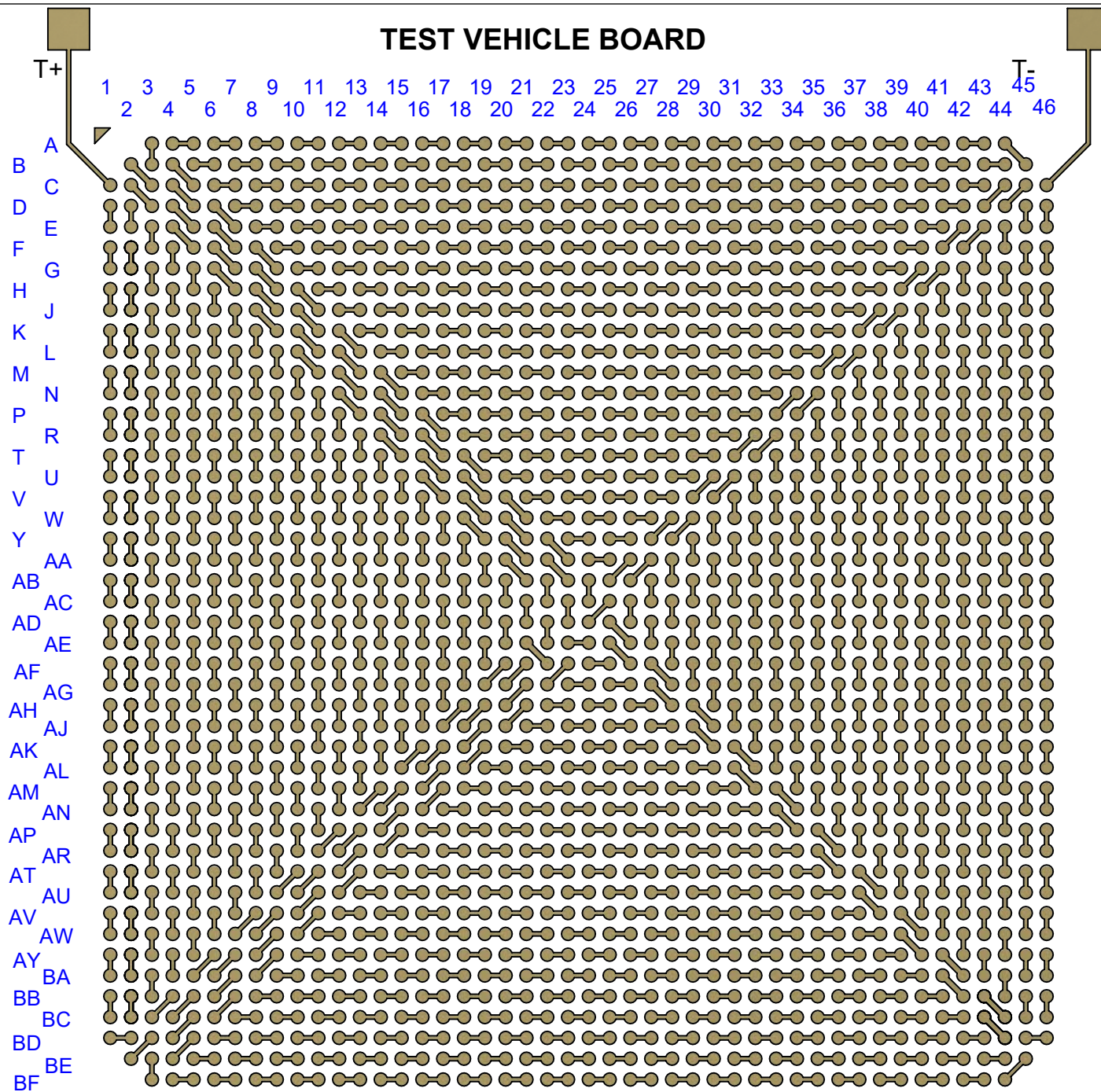

**Notes:**

- 1) PCB BOARD DIMENSIONS ARE PRESENTD ONLY AS A GUIDELINE. DESIGNERS SHOULD USE THEIR OWN EXPERIENCE WHEN DESIGNING PCB.
- 2) PCB Cu BALL PAD DIAMETER 0.635mm [25 MIL].
- 3) PCB DAISY CHAIN TRACING LINE WIDTH 0.204mm [8 MIL].
- 4) SMD (SOLDER MASK DEFINED) PAD OPENING 0.508mm [20 MIL].

<b>TopLine®</b>			
TITLE    LBG2104T1.0-DC467D DAISY CHAIN DUMMY			
SCALE	SIZE	DRAWING NO.	REV
3.5:1	A	514671	A
DO NOT SCALE DRAWING			SHEET 5 OF 9

# AFTER MOUNTING

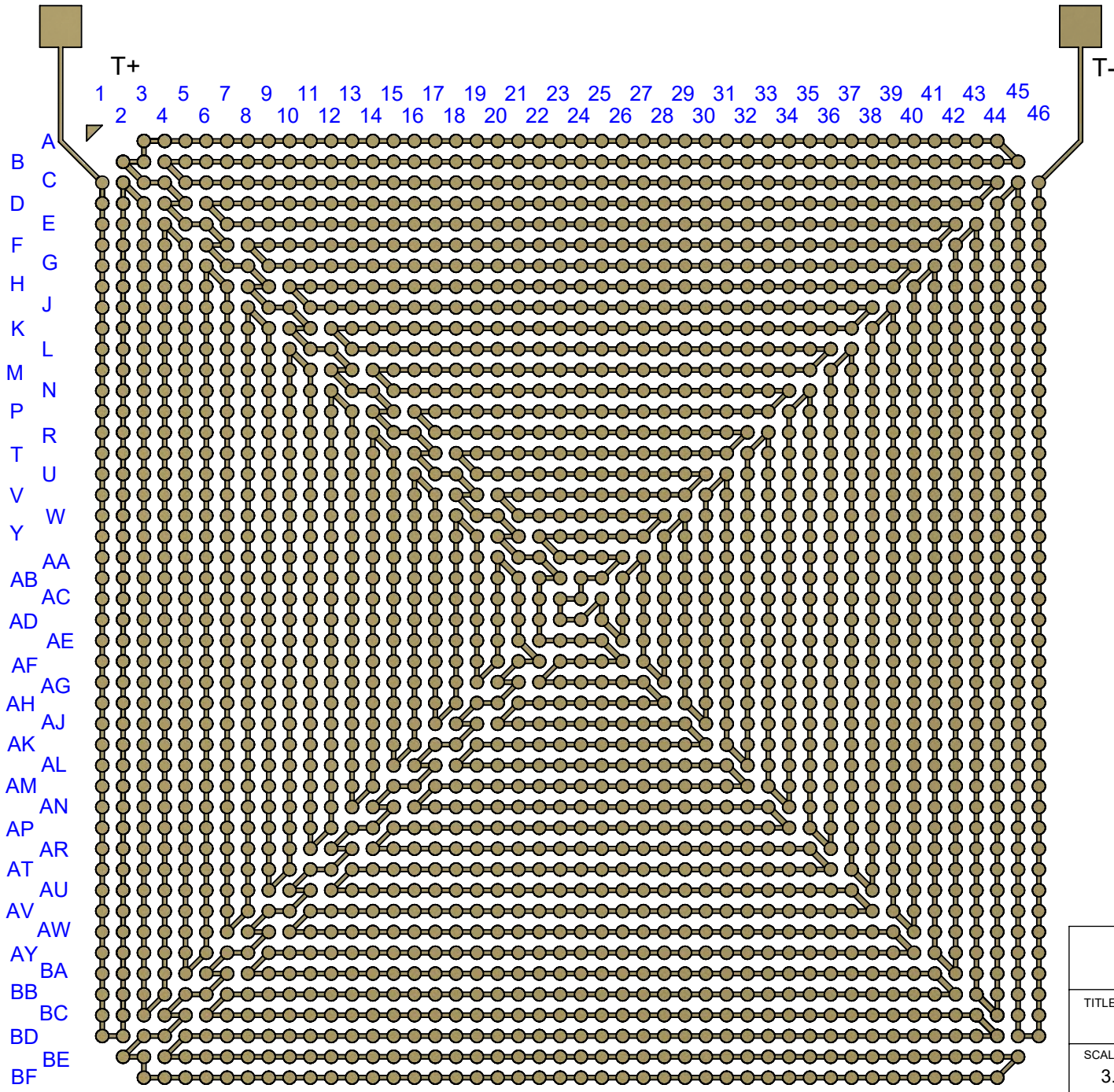

<b>TopLine®</b>			
TITLE    LBG2104T1.0-DC467D DAISY CHAIN DUMMY			
SCALE	SIZE	DRAWING NO.	REV
3.5:1	A	514671	A
DO NOT SCALE DRAWING			SHEET 6 OF 9

**MODEL  
WITH DIE**

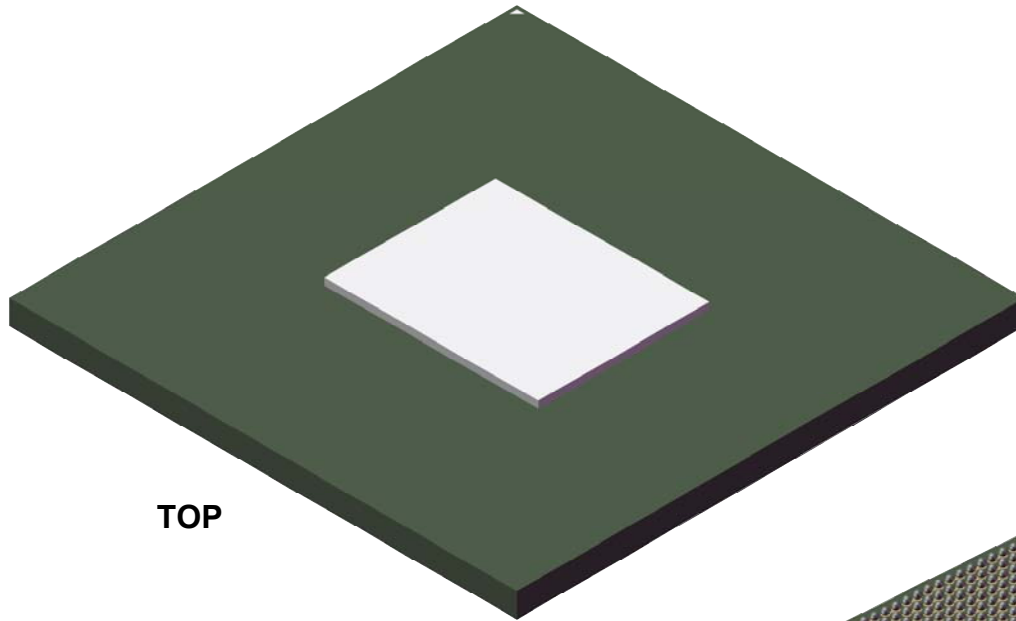

**TOP**

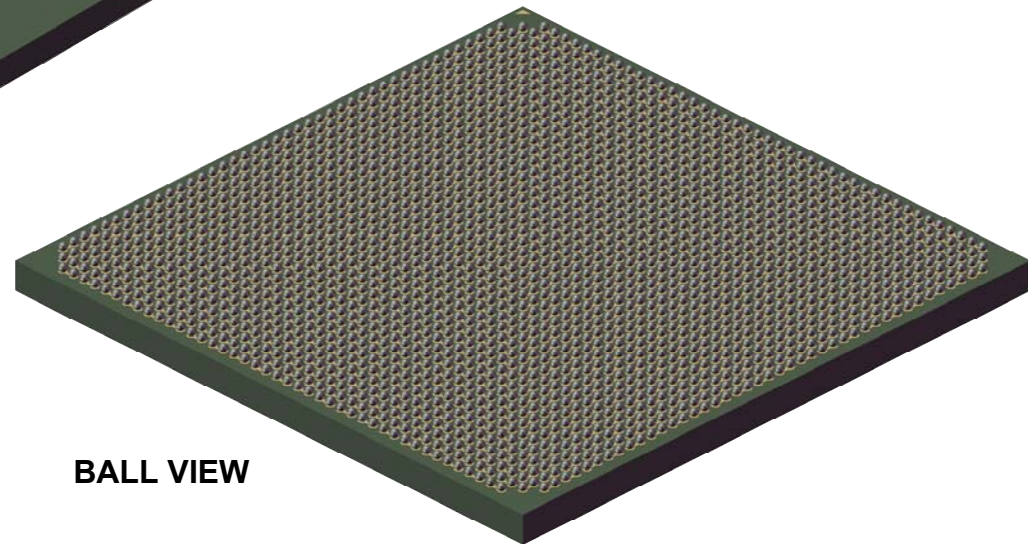

**BALL VIEW**

**TopLine®**

TITLE LPGA2104T1.0-DC467D  
DAISY CHAIN DUMMY

SCALE 2:1	SIZE A	DRAWING NO. 514671	REV A
--------------	-----------	-----------------------	----------

DO NOT SCALE DRAWING

SHEET 7 OF 9

**MODEL  
WITHOUT DIE**

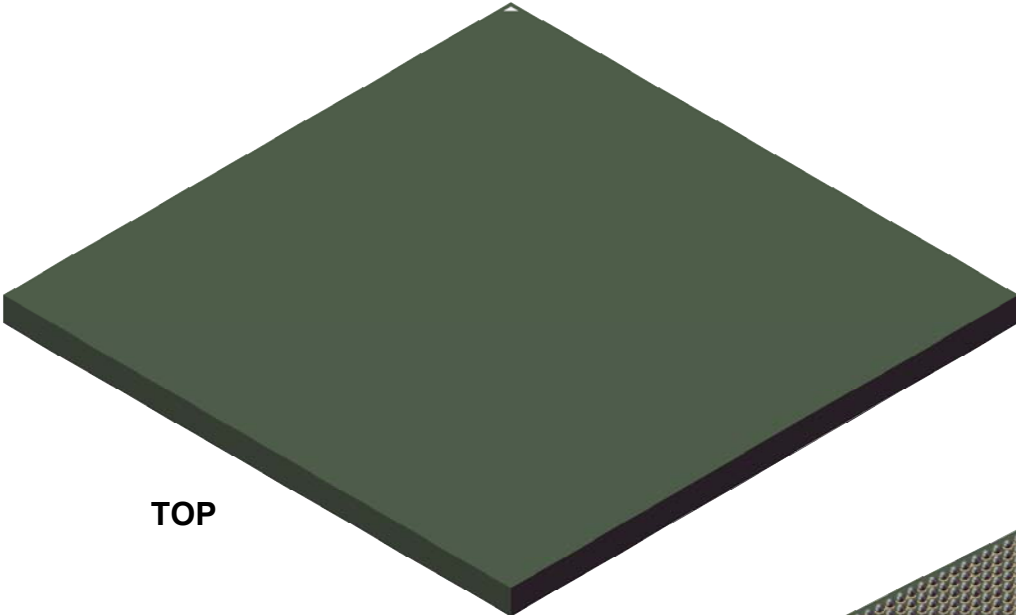

**TOP**

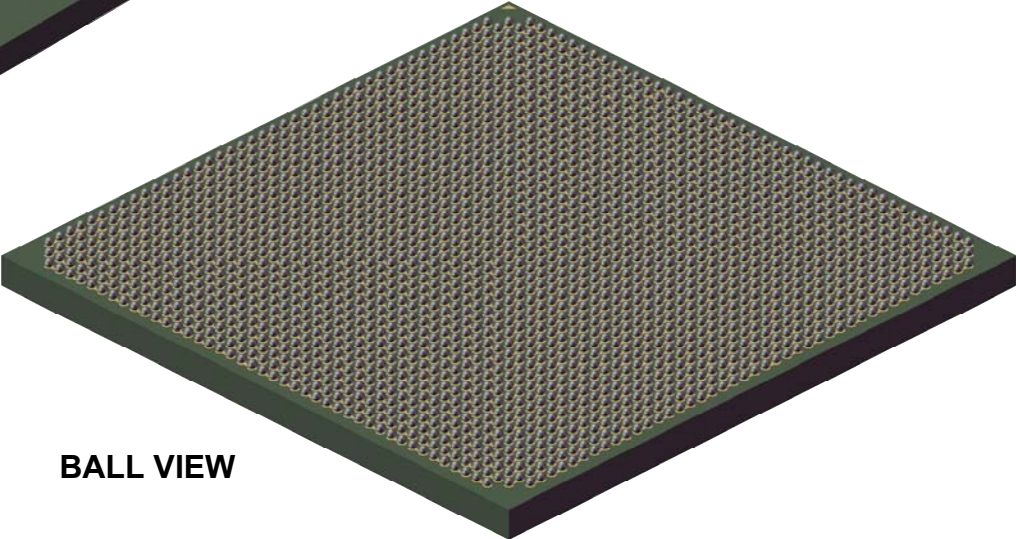

**BALL VIEW**



TITLE LPGA2104T1.0-DC467D  
DAISY CHAIN DUMMY

SCALE 2:1	SIZE A	DRAWING NO. 514671	REV A
--------------	-----------	-----------------------	----------



# BOTTOM SOLDER MASK (RIGHT READING)

46 44 42 40 38 36 34 32 30 28 26 24 22 20 18 16 14 12 10 8 6 4 2  
45 43 41 39 37 35 33 31 29 27 25 23 21 19 17 15 13 11 9 7 5 3 1

A  
B  
C  
D  
E  
F  
G  
H  
J  
K  
L  
M  
N  
P  
R  
T  
U  
V  
W  
Y  
AA  
AB  
AC  
AD  
AE  
AF  
AG  
AH  
AJ  
AK  
AL  
AM  
AN  
AP  
AR  
AT  
AU  
AV  
AW  
AY  
BA  
BB  
BC  
BD  
BE  
BF

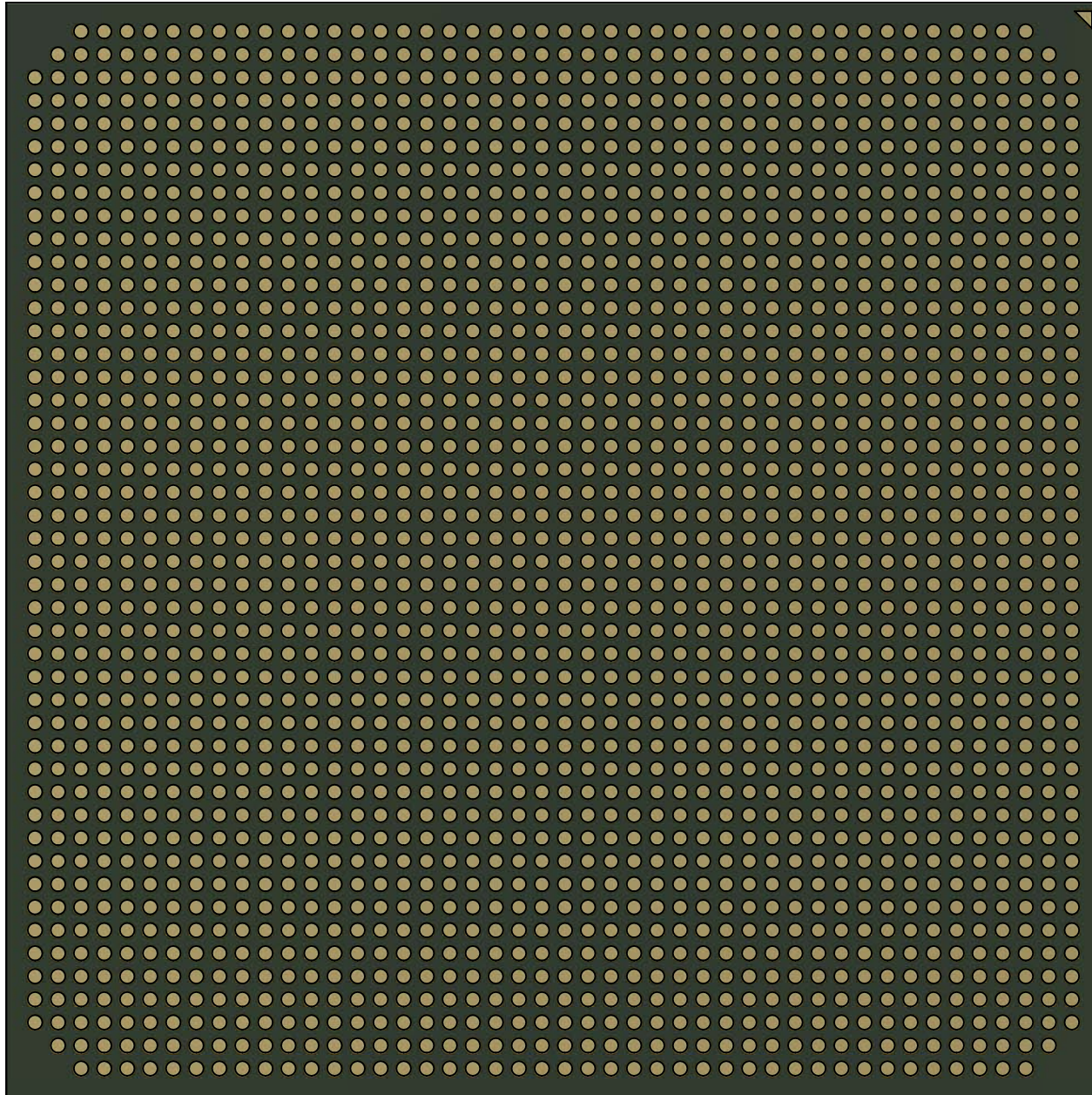

<b>TopLine®</b>			
TITLE SBGA2104T1.0-DC467D DAISY CHAIN DUMMY			
SCALE 3.75:1	SIZE A	DRAWING NO. 514676	REV A
DO NOT SCALE DRAWING			SHEET 9 OF 9